

°C

%RH

Series SRS1/3/4/5

DIGITAL CONTROLLER



CE approved



PRODUCT FEATURE

- Multi-input and multi-range performance
- Small instrument depths (62 mm–65 mm) save space, thus securing a larger installation area.
- Large 13.8 mm bright display (SRS1 & SRS4), 21.8 mm (SRS3) & 22mm (SRS5)
- 1 Pattern, 10 step program function available (option)

■ **Display**

Digital display:	Measured value (PV):	7-segment red LED, 4 digits	
	Target set value (SV):	7-segment green LED, 4 digits	
	SRS1 PV height of character:	Approx. 13.8mm/ SV height of character: Approx. 10.65mm	
	SRS3 PV height of character:	Approx. 21.8mm/ SV height of character: Approx. 14.6mm	
	SRS4 PV height of character:	Approx. 13.8mm/ SV height of character: Approx. 10.65mm	
	SRS5 PV height of character:	Approx. 22.0mm/ SV height of character: Approx. 10.6mm	
	Action display:	LED lamp display:	Color
	Auto tuning (AT):	Lights during standby (flashes during execution):	Green
	Action display (RUN):	Lights during fixed value control operation (FIX):	Green
		Flashes during program RUN program control operation (RUN):	Green
	Control output (OUT):	Lights during contact or SSR drive voltage output:	Green
		For voltage/current output, lights when output is 100%	
		In other cases, flashes at intervals of 0.5 sec. (multiples of 0.5 sec.).	
	Manual control output (MAN):	Flashes during manual output is ON:	Green
	Event (EV1, EV2):	Lights during event output:	Orange
Display resolution:	Differs according to input range (0.001, 0.01, 0.1, 1)		
Display accuracy:	TC: $\pm(0.3\%FS + 1 \text{ digit} + 2 \text{ }^\circ\text{C})$ Pt: $\pm(0.3\%FS + 1 \text{ digit} + 0.1 \text{ }^\circ\text{C})$ mV: $\pm(0.3\%FS + 1 \text{ digit})$ V: $\pm(0.3\%FS + 1 \text{ digit})$		
Display accuracy maintaining range:	23 $^\circ\text{C} \pm 5 \text{ }^\circ\text{C}$		
Measured value display range:	-10~110% of measuring range (not below -273.15 $^\circ\text{C}$: T/C input) -10~110% of measuring range (not below -240 $^\circ\text{C}$: RTD input)		
Display cycle:	500 ms (0.5 seconds)		

■ **Setting**

Setting method:	By operating 4 front panel keys ( ,  ,  , ENT)
Target value setting range:	Same as measuring range (within setting limiter)
Setting limiter:	Individual setting for higher & lower limits are possible Within measuring range (lower limit value < higher limit value)
Setting lock:	OFF, 3-stage setting (1-3)

■ **Input**

● **Input common specification**

input type:	Multi range input (T/C, RTD, mV, V)
● Input scaling:	Settable within measurement range, span 10 digits or more
● Display scaling	Settable at voltage input (mV, V) Scaling range-1999~9999 digit Span 10~9999 digit

● **Thermocouple input (TC)**

Input type:	B, R, S, K, E, J, T, N, PL II, C (WRe 5-26), AuFe-Cr, {U, L (DIN43710) }
Display range:	Within PV limiter (provided that minimum temperature does not fall below -273.15 $^\circ\text{C}$) With or without a decimal point is selectable.
Input resistance:	500k Ω
External resistance tolerable range:	100 Ω or below
Cold junction compensation:	Internal
Internal cold junction compensation accuracy:	$\pm 2^\circ\text{C}$ (5~45 $^\circ\text{C}$)
Burnout function:	Only upscale

● **Resistance temperature**

detector input (RTD):	Pt100 Three-wire type
Display range:	Within input range setting (provided that minimum temperature does not fall below -240 $^\circ\text{C}$) With or without a decimal point is selectable.

Lead wire tolerable resistance range:	Below 10 Ω /1 wire (All wires should have the same resistance.)
Amperage:	Approx. 0.25 mA (All wires should have the same resistance.)

● Voltage input (mV)

Input type:	-10–50 mV DC
Display:	Programming scaling (Within PV limiter, rounded off to the lowest displayed place from the next lower place.)
Input resistance:	Approx. 500kΩ or above
Scaling:	Valid when voltage input
Scaling range:	-1999–9999 digit
Span:	10–9999 digit
Decimal point position:	Without, settable from 0.1, 0.01, or 0.001
Sampling cycle:	0.5 seconds
PV bias:	-1999–2000 digits
PV ramp:	0.500–1.500 times input value
PV filter:	OFF, 1–100 sec.
Scaleover display:	LLLL, HHHH
Isolation:	Uninsulated from system and DI, but insulated from other input

■ Control mode

Expert PID control with auto-tuning function

● Control output

Contact (Y):	Contact (1a), 240V AC, 2.5 A: Resistive load/1 A: Inductive load
SSR drive voltage (P):	12 V ± 1.5 V DC (max. load current 20 mA)
Current (I):	4–20 mA, max. load resistance 600Ω
Voltage (V):	0–10 V, max. current 2 mA
Output resolution:	0.01% (1/10000)
No. of SV:	2
No. of PID:	2 classes
Proportional band:	OFF, 0.1–999.9% (ON-OFF action when OFF)
Integral time:	OFF, 1–6000 sec. (P or PD action when OFF)
Derivative time:	OFF, 1–3600 sec. (P or PI action when OFF)
Target value function:	OFF, 0.01–1.00
Output limiter:	Lower limit 0.0%–99.9%, higher limit 0.1–100.0% (lower limit value < Higher limit value)
Manual reset:	-50.0–50.0% (Valid when I = OFF)
ON-OFF hysteresis:	1–999 digits (Valid when P = OFF)
Proportional cycle:	1–120 sec., 1 sec. step
Control output characteristics:	Reverse/direct selectable

● Manual control

Output setting range:	0.0–100.0 %, 0.1% step
Output update cycle:	500 ms (0.5 sec.)
Manual ↔ auto tuning:	Balanceless/bumpless action (switch through front panel key switch or external control input [DI])

■ Event output (EV)

No. of output:	Standard 2 points (EV1-EV2)
Constant rating:	Contact (1a), 240 V AC, 1 A: Resistive load (common)
Function:	Display: Action
	Hd: Higher limit deviation value action
	Ld: Lower limit deviation value action
	od: Outside higher/lower limit deviation action
	id: Inside higher/lower limit deviation action
	HA: Higher limit absolute value action
	LA: Lower limit absolute value action
	SO: Scale over
	RUN: Control execution
	ROT1: Control output inverted output (contact output only)
	STPS: Step signal
	PTNS: Pattern signal
	ENDS: Program end signal
	HOLD: Hold signal
	PROG: Program signal
	U_SL: Upslope signal
	D_SL: Downslope signal
	GUA: Guarantee soak

● **Setting range**

Absolute value:	Within both measuring range and PV limiter (both higher and lower limit)
Deviation:	-1999–2000 digits (both higher and lower limit)
Higher/lower deviation:	0–2000 digits (both inside and outside)
Action:	ON-OFF action
Hysteresis:	1–999 digits
Action delay time:	OFF, 1–9999 sec.
Standby action:	Separate setting (separate output), selectable from any of 4 types below 1) Without 2) Standby 1 (when starting power, when RST ON → OFF) 3) Standby 2 (when starting power, when RST ON → OFF, when execution SV is changed) 4) Standby 3 (Does not output when there is input abnormality.)
Latching:	Selection from ON/OFF
Output characteristics:	Selection from NO/NC
Output update cycle:	500 ms (0.5 sec.)
Isolation:	Insulated from all input and output (uninsulated within EV)

■ **External control input (DI)**

● No. of input:	Standard 1 point	
● Input type:	Level input, edge input	
● Input rating:	Voltage 5 V DC (2.5 mA/1 input)	
● Input action:	Non-voltage contact or open collector	
● Input holding time:	500 ms (0.5 sec.)	
● Function:	Display:	Action:
	NON	No selection
	RUN1:	Starts control when ON: Level
	RUN2:	Starts control when ON: Edge
	MAN:	Manual control output mode: Level
	AT:	AT execution: Edge
	SV:	SV switch:
	RAMP:	Ramp halt:
	ACT:	Output characteristics: Level
	L_RS:	Event latching release: Edge
	PROG:	Program switch: Level
	HLD:	Hold signal:
	ADV:	Advance signal: Edge
● Isolation:	Uninsulated from input and system, but insulated with other	

■ **Program (option)**

● No. of pattern:	1
● No. of step:	10
● Power failure compensation:	Without
● Guarantee soak zone:	oFF, 1–999 digits
● Standard mode:	Start SV value/PV value Selectable
● No. of pattern execution:	1–9999
● Time accuracy:	Set value × 0.3%

■ General specifications

- Data storage: By non-volatile memory (EEPROM)
- Operating ambient
 - Ambient temperature: -10–50 °C
 - Humidity range: Below 90%RH (no condensation)
 - Storage temperature: -20–65 °C
 - Over voltage category: II
 - Elevation: Max. 2000 m
 - Pollution class: 2 (IEC 60664)
 - Supply voltage: 100–240 V AC ± 10% (50/60 Hz)
- Power consumption: 10 VA
- Input noise removal ratio: Normal mode: 50 dB or above (50/60 Hz)
- Common mode: 120 dB or above (50/60 Hz)
- Applicable standard: Safety: IEC61010-1 and EN61010-1
IEC61010-2-030 and EN61010-2-030
EMC: EN61326-1
RoHS: EN50581

- Power supply
 - short-break time: Within 50 ms, normal action continuation (when 200V)
- Insulation resistance: Input-output terminal and power terminal interval, 500 V DC, 20MΩ or above
- Dielectric strength: Input-output terminal and power terminal interval, 2300 V AC, 1 min.
- Material of case: Resin mold (UL94V-1 equivalent)

- External dimensions/
Panel cutout/
Weight/
Applicable panel thickness

	External dimensions, panel depth	Panel cutout	Weight	Applicable panel thickness
SRS1	H48 × W48 × D66 mm, 62 mm	H45×W45 mm	Approx. 100 g	1.0–3.5 mm
SRS3	H96 × W96 × D69 mm, 65 mm	H92×W92 mm	Approx. 190 g	
SRS4	H96 × W96 × D69 mm, 62 mm	H92×W45 mm	Approx. 120 g	
SRS5	H48 × W96 × D66 mm, 62 mm	H45×W92 mm	Approx. 120 g	

- Mounting: Panel flush mounting

ITEM	CODE	SPECIFICATIONS	
SERIES	SRS1 -	DIN 48x48 Digital Controller	
	SRS3 -	DIN 96x96 Digital Controller	
	SRS4 -	DIN 48x96 Digital Controller	
	SRS5 -	DIN 96x48 Digital Controller	
CONTROL OUTPUT	Y -	Contact: 1a, Contact capacity: 240 V AC 2A/resistive load Proportional cycle: 1-120 sec.	
	I -	Current: 4-20 mA DC Load resistance: 600 Ω max. (OPTION)	
	P -	SSR drive voltage: 12 V±1.5 V DC/20mA max. Proportional cycle: 1-120 sec.	
	V -	Voltage: 0-10 V DC Load current: 2 mA max.	
PROGRAM FUNCTION (OPTION)	N	None	
	P	1 patterns, 10 steps	
EVENT OUTPUT	1	Contact: 2 points x 1a, 240 V AC, 1 A: Resistive load (common)	
REMARKS	0	Without	
	6	Voltage input (V)	
	9	With (Please consult before ordering.)	

TERMINAL COVER

Model	Parts No.	Remarks
SRS1	QCR001	One touch mounting
SRS3	QCR006	One touch mounting
SRS4	QCR006	One touch mounting
SRS5	QCR006	One touch mounting

MEASURING RANGE CODES

Input Type			Measuring range (°C)	Measuring range (°F)	
Multi input	Thermocouple	B *6	01 *1	0 - 1800 °C	0 - 3300 °F
		R	02	-50 - 1700 °C	0 - 3100 °F
		S	03	0 - 1700 °C	0 - 3100 °F
		K	04 *2	-199.9 - 400.0 °C	-300 - 750 °F
			05	0 - 1370 °C	0 - 2500 °F
		E	06	0 - 700 °C	0 - 1300 °F
		J	07 *2	-200 - 600 °C	-320 - 1100 °F
		T *6	08 *2	-270 - 400 °C	-450 - 750 °F
		N	09	0 - 1300 °C	0 - 2300 °F
		PLII *3	10	0 - 1300 °C	0 - 2300 °F
	C (WRe 5-26)	11	0 - 2300 °C	0 - 4200 °F	
	U *3	12 *2	-199.9 - 400.0 °C	-300 - 750 °F	
	L	13	0 - 600 °C	0 - 1100 °F	
Kelvin	K	14 *4	10.0-350.0 K		
	AuFe-Cr	15 *5	0.0-350.0 K		
R.T.D.	Pt100	34	-199.9 - 300.0 °C	-300 - 600 °F	
mV	-10-50 mV	72	Scaling range: -1999-9999		
Voltage	V	86	Span: 10-9999 digit		

*1 Thermocouple B: Accuracy guarantee is not applicable to 400 °C and 750 °F or below.

*2 Thermocouple K (Celsius, Fahrenheit), E, J, T, U: Accuracy of indicated values below -100 °C and -148 °F is ± (1.5%FS + 1 digit).

*3 Thermocouple PL II, U: Accuracy of indicated values is ±(1.5%FS + 1 digit + 1 °C).

*4 Thermocouple K (Kelvin) accuracy temperature range:

10.0-30.0K: ±(2.0%FS + 1 digit + 1K) Provided the wire resistance is 10Ω or below

31.0-70.0K: ±(1.5%FS + 1 digit + 1K) Provided the wire resistance is 10Ω or below

71.0-350.0K: ±(1.0%FS + 1 digit + 1K)

*5 Thermocouple AuFe, Cr: Accuracy of indicated values is ±(1.0%FS + 1K).

*6 Thermocouple B, T: Accuracy of indicated values below these temperatures is subject to wire resistance below 50Ω:

B: 500 °C (930 °F)

T: -240 °C (-400 °F)

*7 Temperatures below -273 °C (-459 °F) are subject to scaleover display.

*8 With or without a decimal point is selectable for TC and Pt.

NOTE: Unless otherwise specified, the measuring range will be set as follows when shipped from the factory:

Input range	Code	Measuring range
Multi-input	05	K 0-1370 °C
Voltage input	86	0-10 V

NOTE: For current input install input terminals of the specified receiving impedance (250Ω) and use code 86 (0-10 V).

Unit: mm

■ SRS1

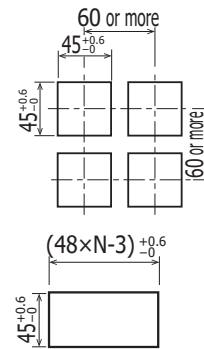
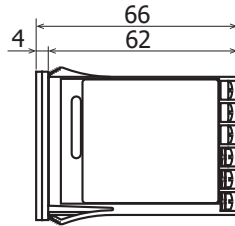
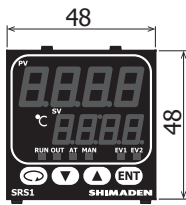

In the case of closely-mounted horizontally
N=The number of instruments
(When closely-mounted in series, cold junction compensation accuracy will be $\pm 3^{\circ}\text{C}$.)

■ SRS3

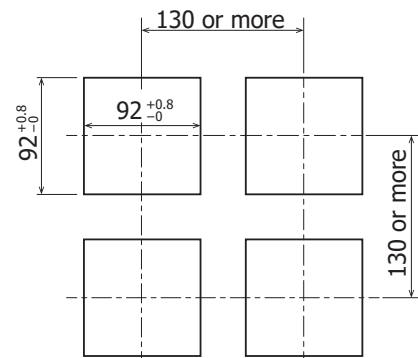
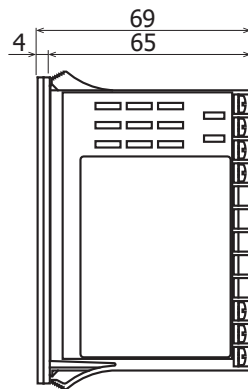
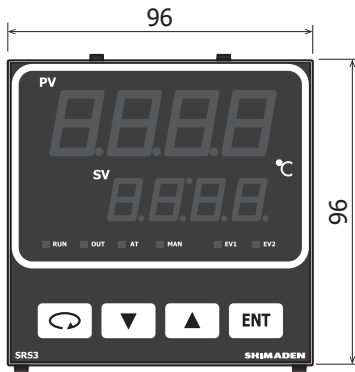

■ SRS4

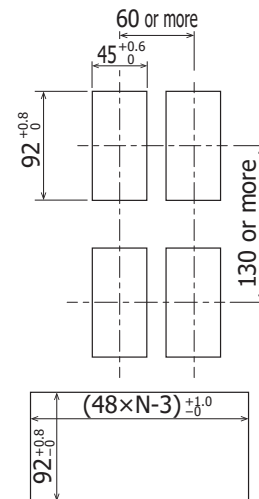
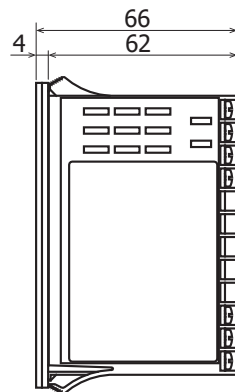

In the case of closely-mounted horizontally
N=The number of instruments
(When closely-mounted in series, cold junction compensation accuracy will be $\pm 3^{\circ}\text{C}$.)

■ SRS5

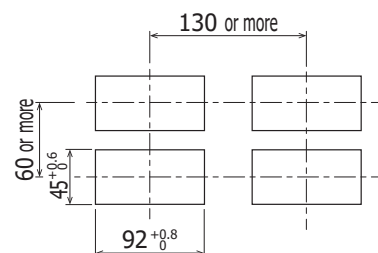
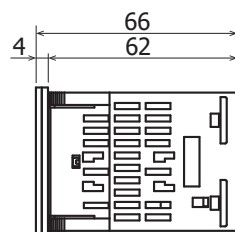
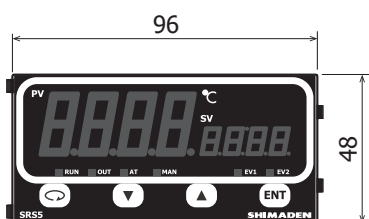

SRS1

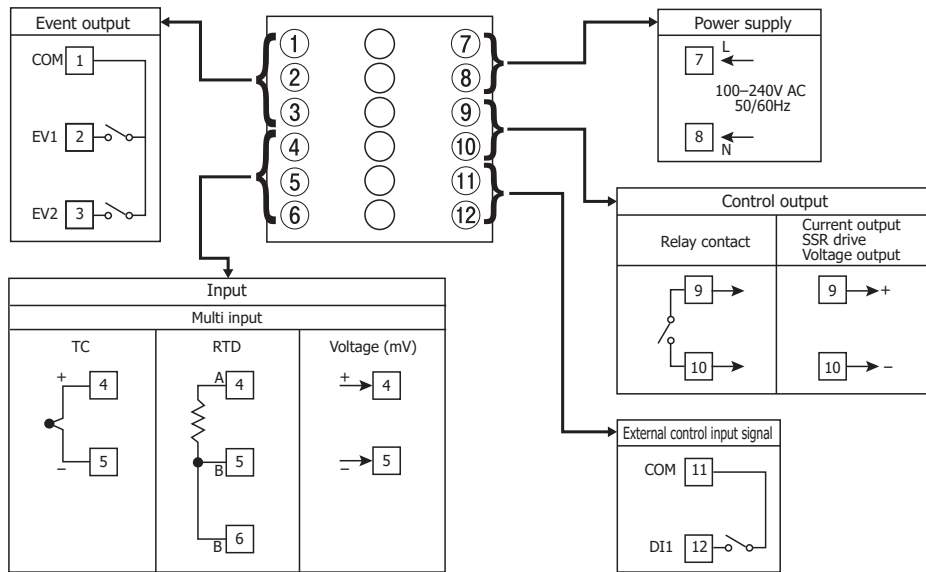

Crimp-type terminals fit M3 screws. Use crimp-type terminals that are no wider than 6.0 mm.

SRS3/4

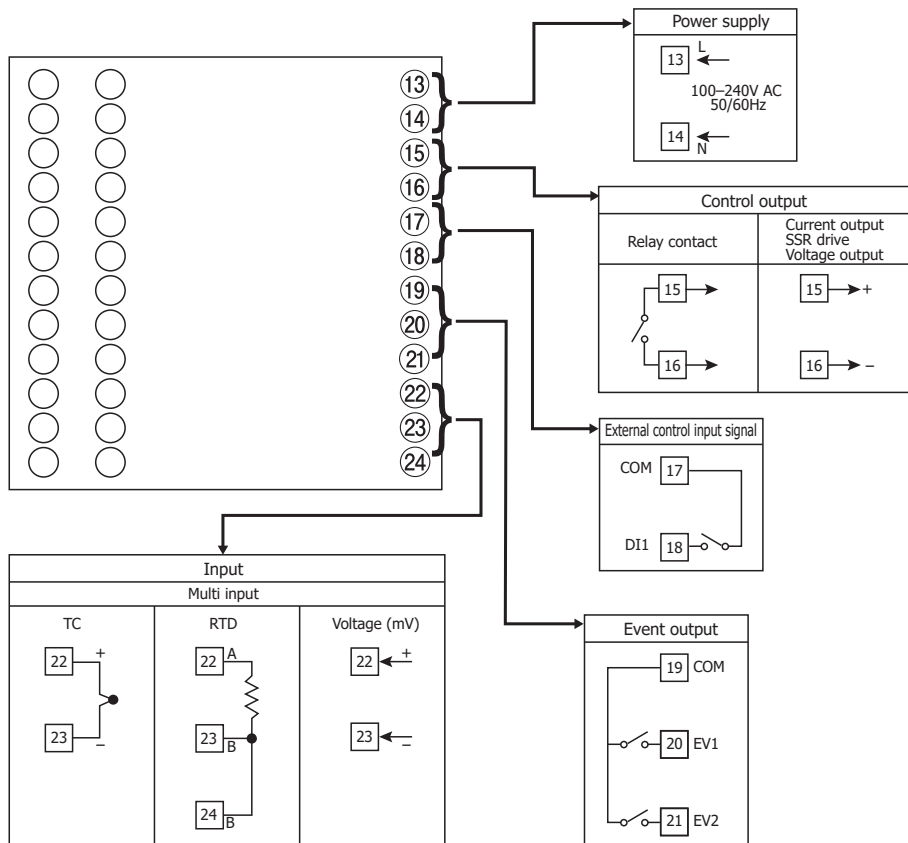

Crimp-type terminals fit M3 screws. Use crimp-type terminals that are no wider than 6.0 mm.

SRS5

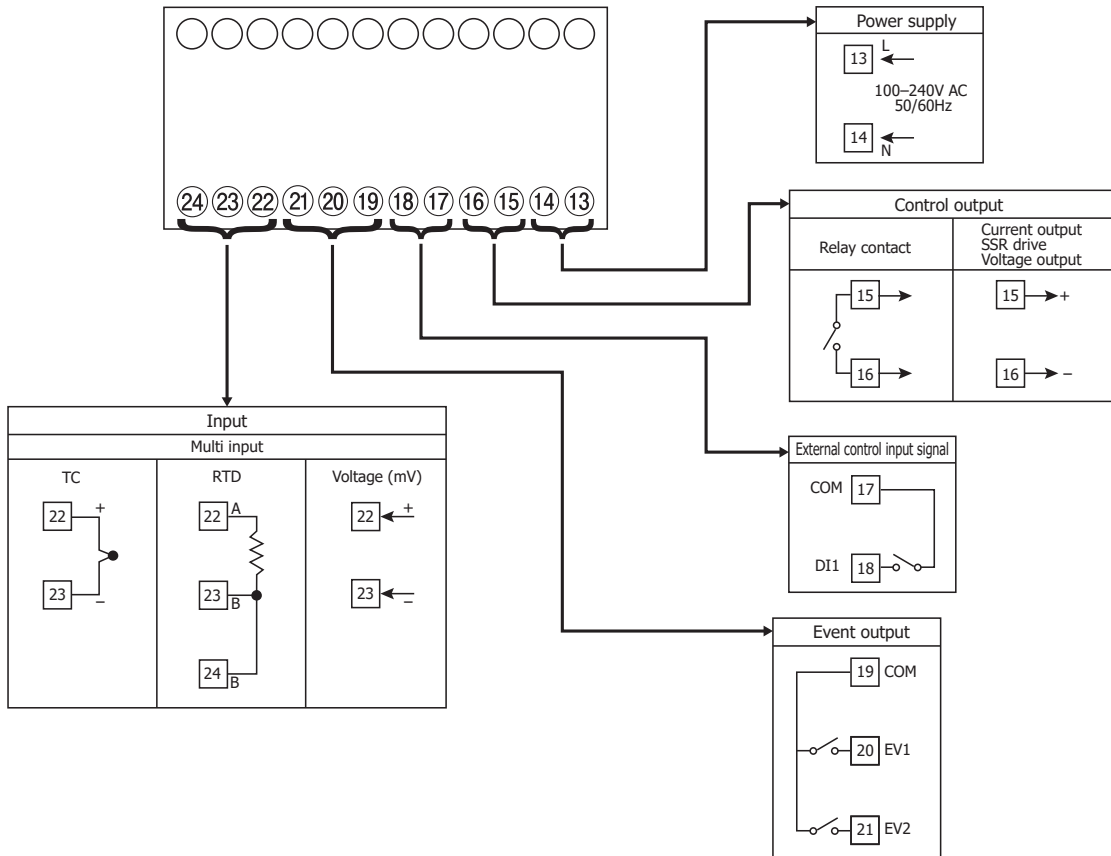

Crimp-type terminals fit M3 screws. Use crimp-type terminals that are no wider than 6.0 mm.

(The contents of this brochure are subject to change without notice.)

TASHIKA CO., LTD.

1-12, Kaiyo-cho, Ashiya, 659-0035, JAPAN
 Tel: + 81-797-23-9035 Fax: + 81-797-23-2105
 e-mail: sales@tashika.co.jp URL: www.tashika.co.jp